



HEXAGON
METROLOGY

FACTSHEET

LEITZ SPECIFICATION



On the safe side with Leitz

For almost all Leitz measuring machines the respective accuracy values are true for a whole range of styli, with dimensions from $\varnothing 3 \times 35$ mm to $\varnothing 8 \times 130$ mm. With each Leitz CMM you are certain to invest in a high accuracy quality product.

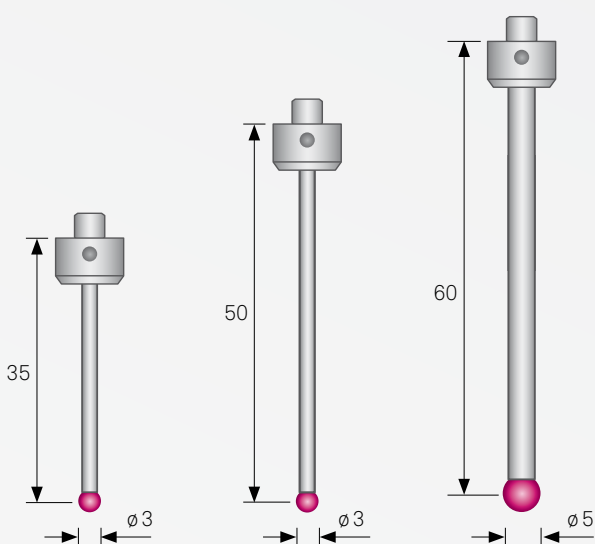

Leitz styli

Specifications for Leitz CMMs are valid for all Leitz styli with

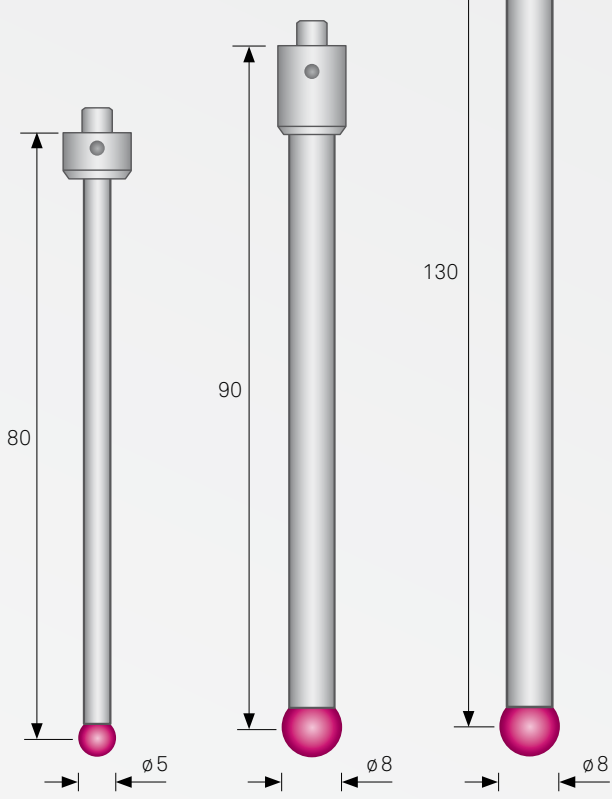
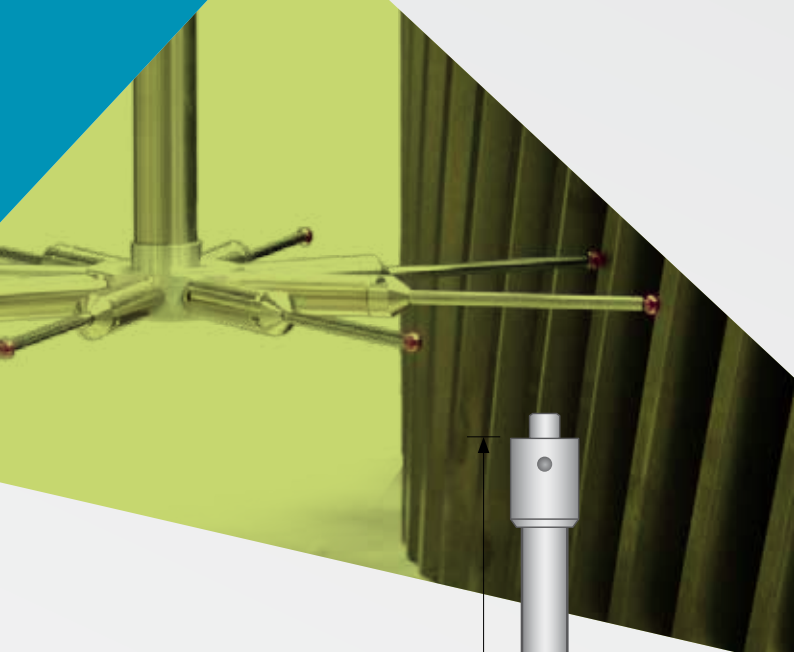

Dimensions from $\varnothing 3 \times 35$ mm to $\varnothing 8 \times 130$ mm.

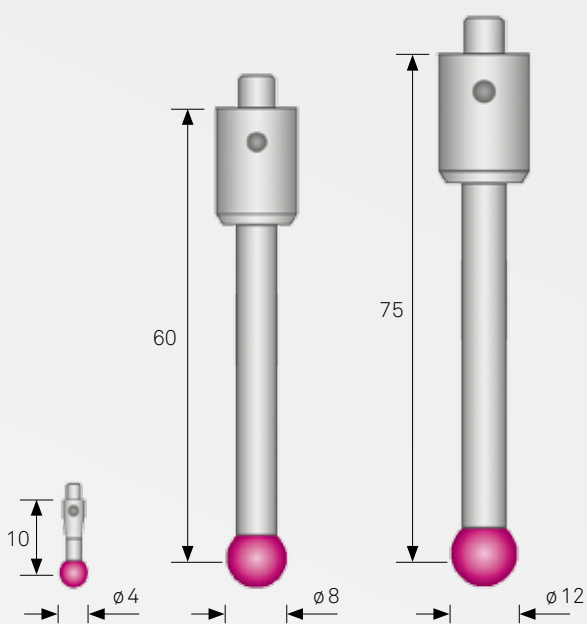
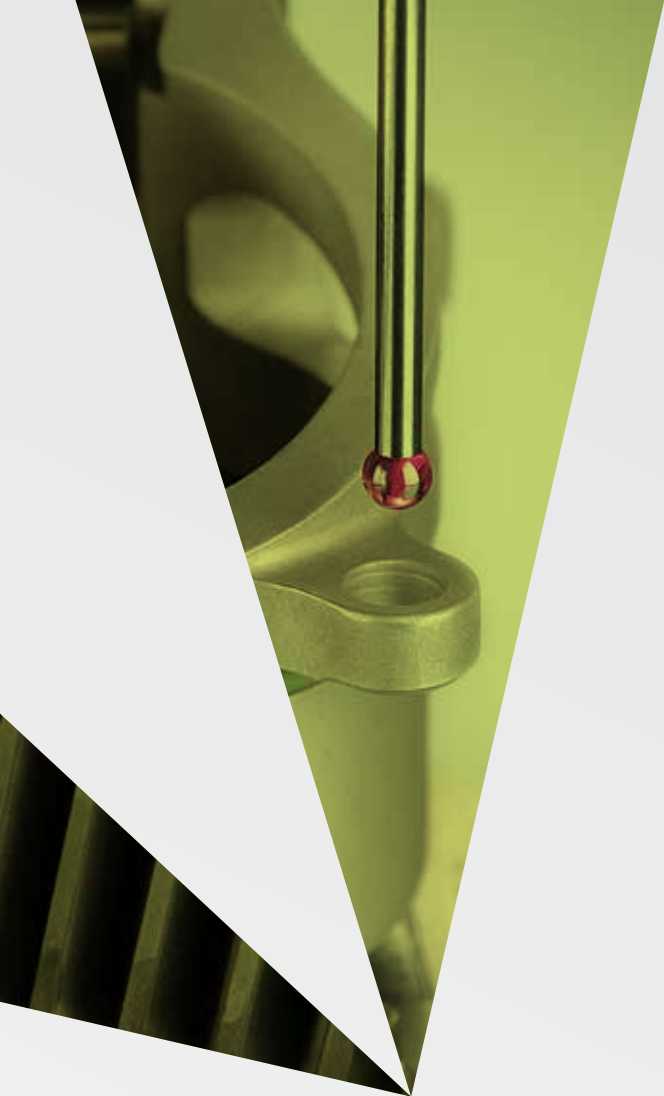

CMM-maker 1

CMM-maker 2

CMM-maker 3



Be informed, read the fine-print

When choosing the appropriate coordinate measuring machine (CMM) it is worth having a closer look at the measuring error stated given by the manufacturer.

There are great differences among the different makers. Important information is often hidden in the fine-print of the respective data sheets. Whereas Leitz specifies the accuracy for a full range of styli, there are others which publish the measuring error only for one stylus.



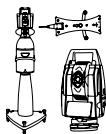

LASER TRACKERS & STATIONS



PORTABLE MEASURING ARMS

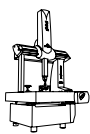

BRIDGE CMMS

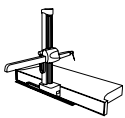

HORIZONTAL ARM CMMS

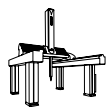

GANTRY CMMS



MULTISENSOR & OPTICAL SYSTEMS



WHITE LIGHT SCANNERS

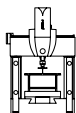

ULTRA HIGH ACCURACY CMMS



SENSORS



PRECISION MEASURING INSTRUMENTS



SOFTWARE SOLUTIONS



HEXAGON METROLOGY

Hexagon Metrology offers a comprehensive range of products and services for all industrial metrology applications in sectors such as automotive, aerospace, energy and medical. We support our customers with actionable measurement information along the complete life cycle of a product – from development and design to production, assembly and final inspection.

With more than 20 production facilities and 70 Precision Centres for service and demonstrations, and a network of over 100 distribution partners on five continents, we empower our customers to fully control their manufacturing processes, enhancing the quality of products and increasing efficiency in manufacturing plants around the world.

For more information, visit www.hexagonmetrology.com

Hexagon Metrology is part of Hexagon (Nordic exchange: HEXA B). Hexagon is a leading global provider of design, measurement and visualisation technologies that enable customers to design, measure and position objects, and process and present data.

Learn more at www.hexagon.com

© 2014 Hexagon Metrology. Part of Hexagon

All rights reserved. Due to continuing product development, Hexagon Metrology reserves the right to change product specifications without prior notice.